

AG ENERGY GROUP

We make
life
easier for
farmers

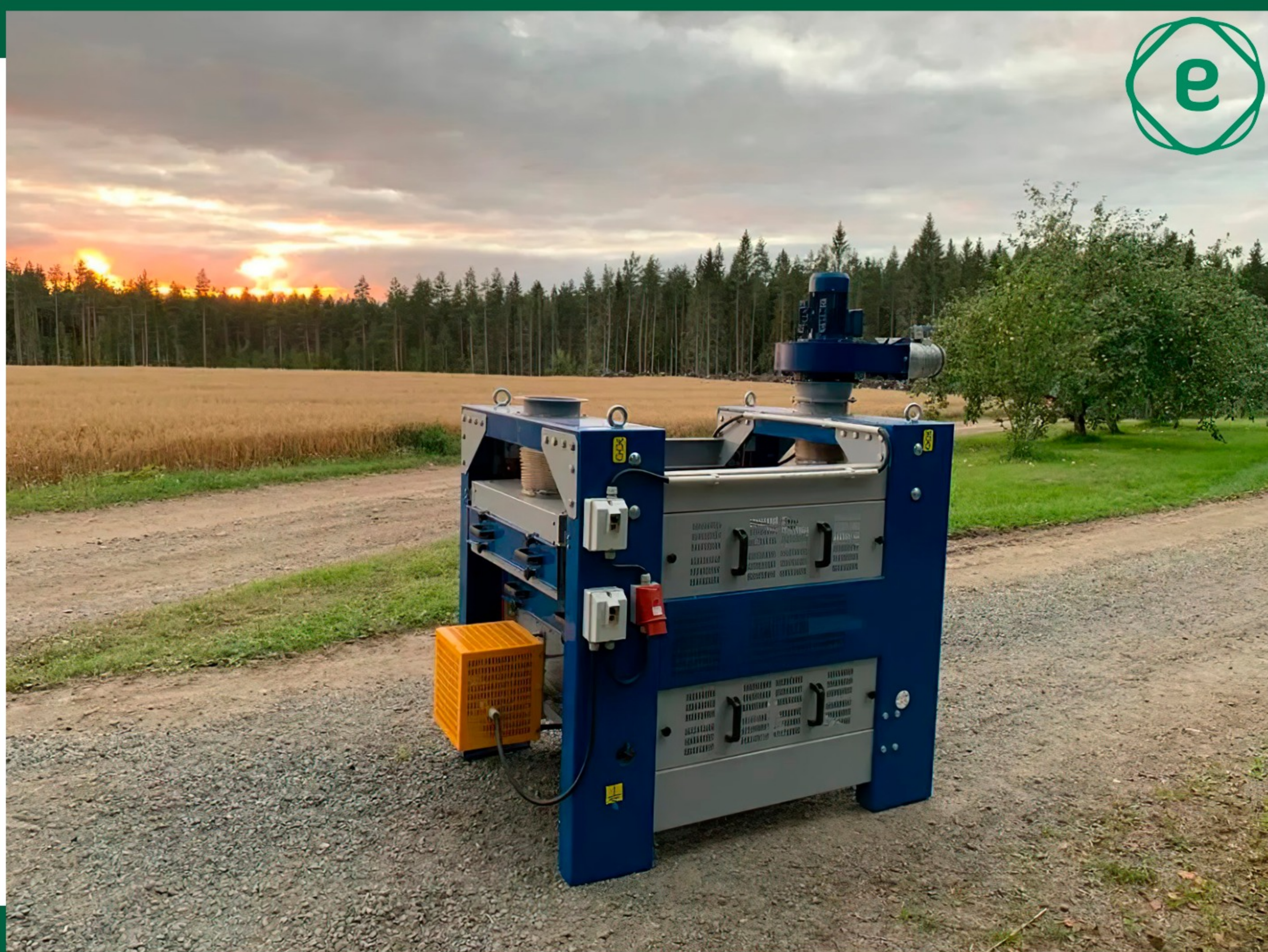

AGM aerodynamic grain cleaner



Ideal for cleaning:

- Cleaning of the grain from Impurities
- Separation of one crop from another
- Separation of contaminated grain and normal grain

Advantages

- Capacities range from 5 to 50 tonnes per hour at maximum load
- Energy saving
- You can install the unit indoors
- Perfect handling of wet and dry grain
Grain is not damaged by compressed air
- As an optional extra, the AGM 5 can be equipped with a drum pre-cleaner, cyclone and screw conveyor.

Description

The AGM model grain cleaners are capable of effectively removing debris and various impurities from the crop and separating it into different fractions depending on the size of the particles. The operating principle: The grain (starting material), which falls under the influence of the air flow has a different trajectory depending on the weight, shape, surface roughness and floating ability of each grain. As a result, both fine seeds or grains and coarse seeds (beans, beans, maize) can be cleaned

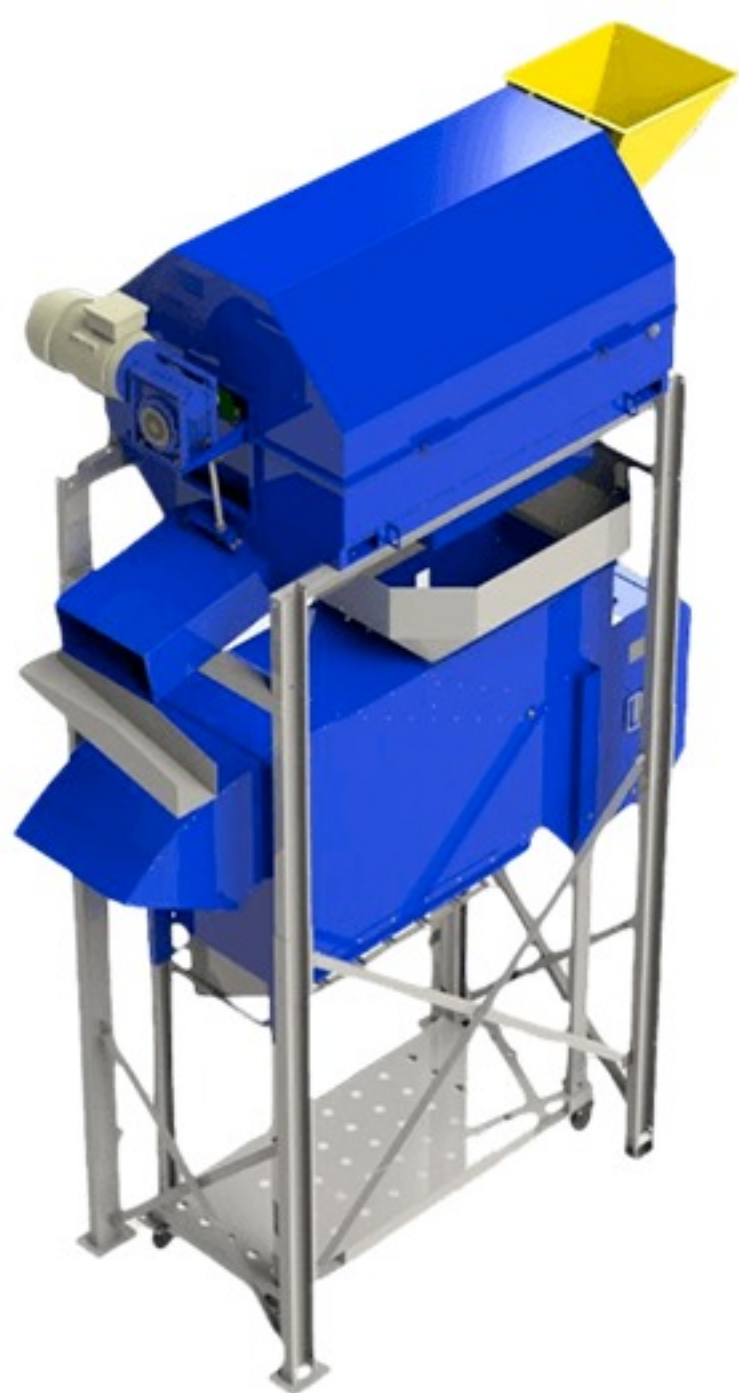

AGM 5 + BS 5



AGM 5 + PSE



AGM 5 + Cyclone

AGM MODELS

| Properties | AGM 5 | AGM 15 | AGM 20 | AGM 30 | AGM 40 | AGM 50 |
|------------------------------|---------|---------|---------|---------|---------|---------|
| Capacity, up to t/h | 5 | 15 | 20 | 30 | 40 | 50 |
| Electricity consumption, kWh | 0.2-0.6 | 0.2-2.5 | 0.2-3.3 | 0.2-4.3 | 0.2-6.0 | 0.2-6.8 |
| Net weight, kg | 160 | 360 | 370 | 405 | 450 | 460 |
| -length, mm | 2040 | 2990 | 2990 | 2310 | 2310 | 2310 |
| -Width, mm | 605 | 685 | 685 | 965 | 1130 | 1130 |
| -Height, mm | 2070 | 2050 | 2050 | 2230 | 2230 | 2230 |

Detailed information

- Information on BS 5 can be found on the page - 10
- Information on PSE can be found on the page - 23



AGM 5



AGM 15



AGM 20



AGM 30



AGM 40



AGM 50

Sieve Grain Cleaner BISS



BISS comes with:

- Free sieve set on order
- Full 1-year warranty
- Data sheet with instructions

Advantages

- High cleaning performance of various Contaminants in all geometric sizes
- Energy saving
- Easy change of sieves
- Easy to set up and use
- Self-cleaning mechanism with special rubber balls
- Grain of any purity and degree of moisture can be used for be used for cleaning

Description

The BISS is a modern sieve separator designed for cleaning cereals, pulses, oilseeds, perennial and annual grasses and other field crops, whereby the waste is into several fractions. The purification is done by passing the grain through a sieve with sieve of a specific shape and size. The BISS is designed as a universal separator and can be operate in the pre-cleaning and final cleaning modes.

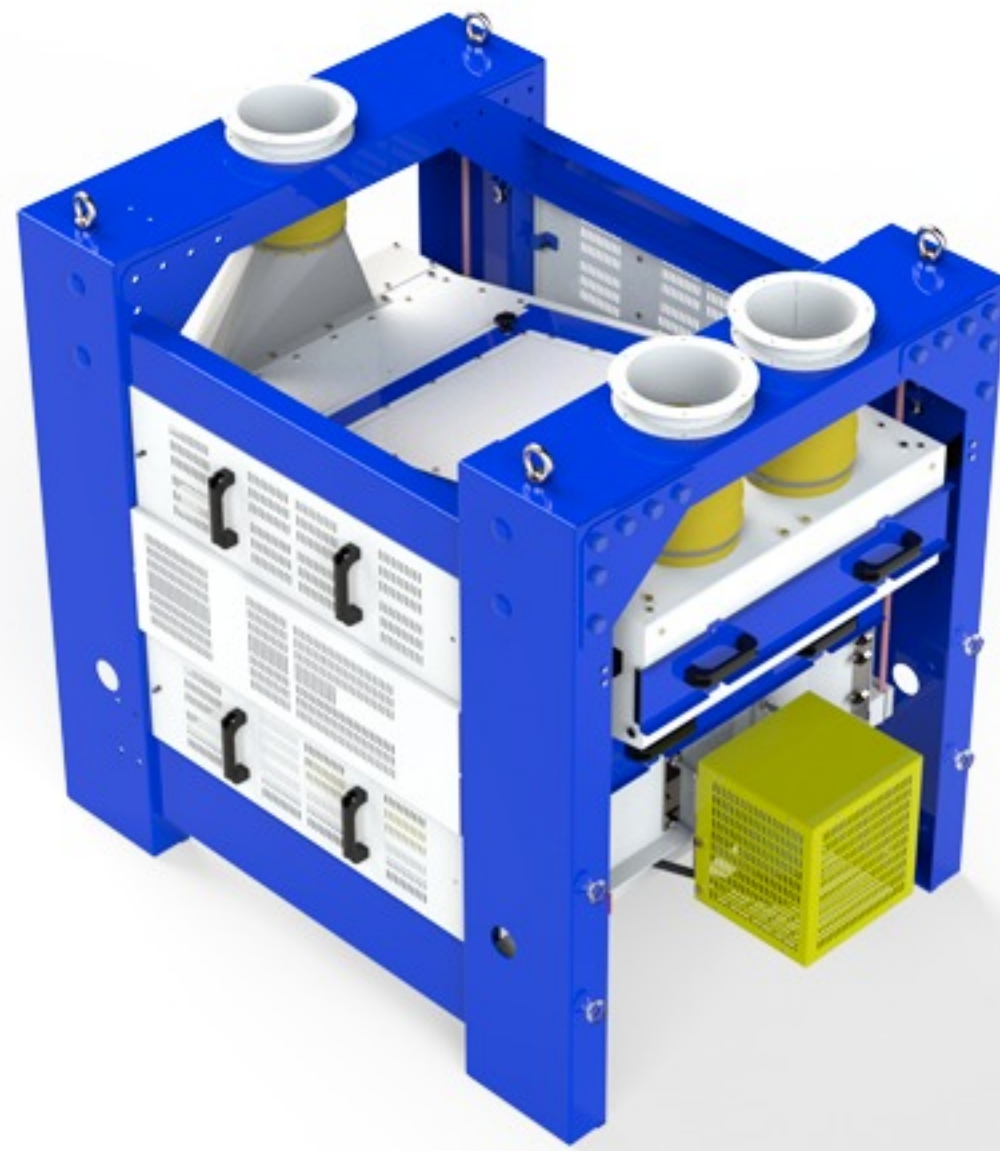

BISS regular version

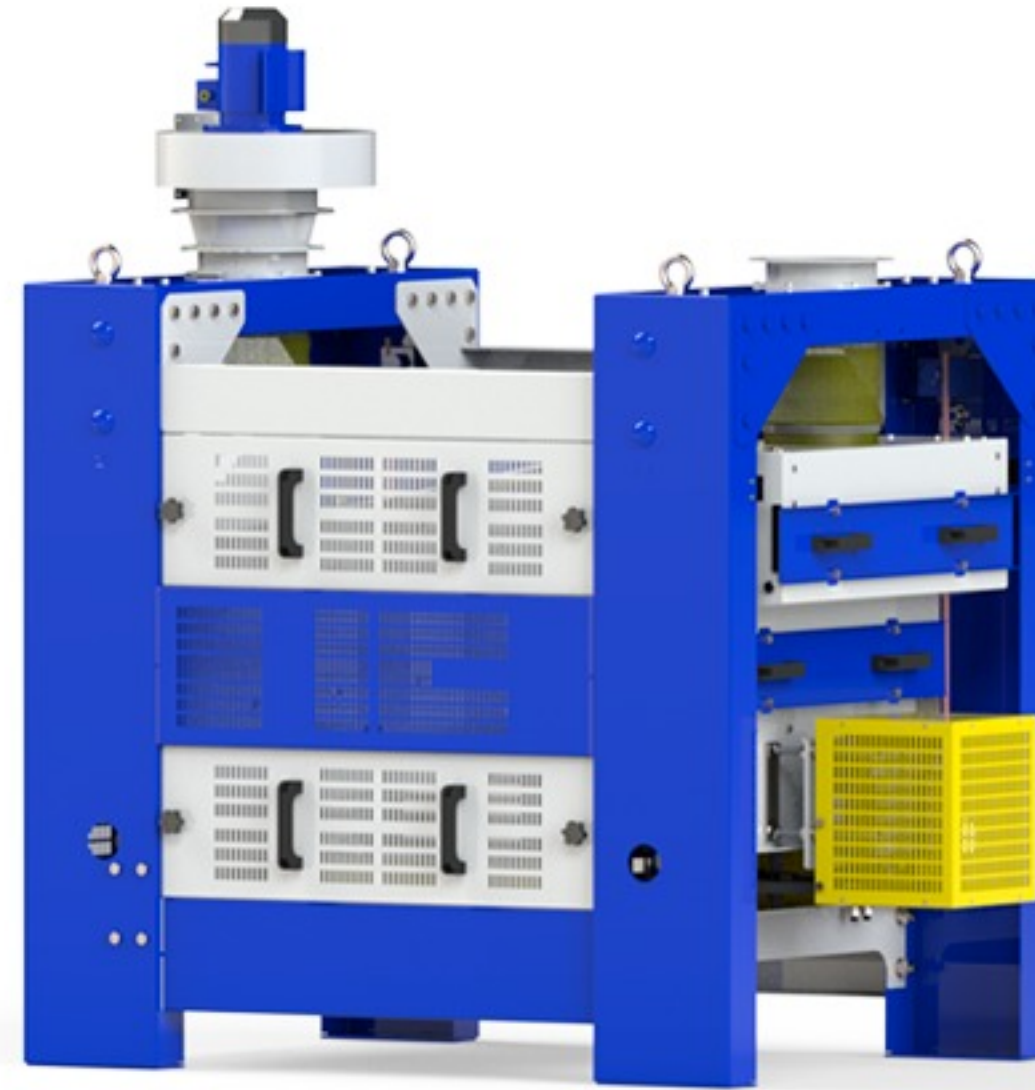

BISS + fan

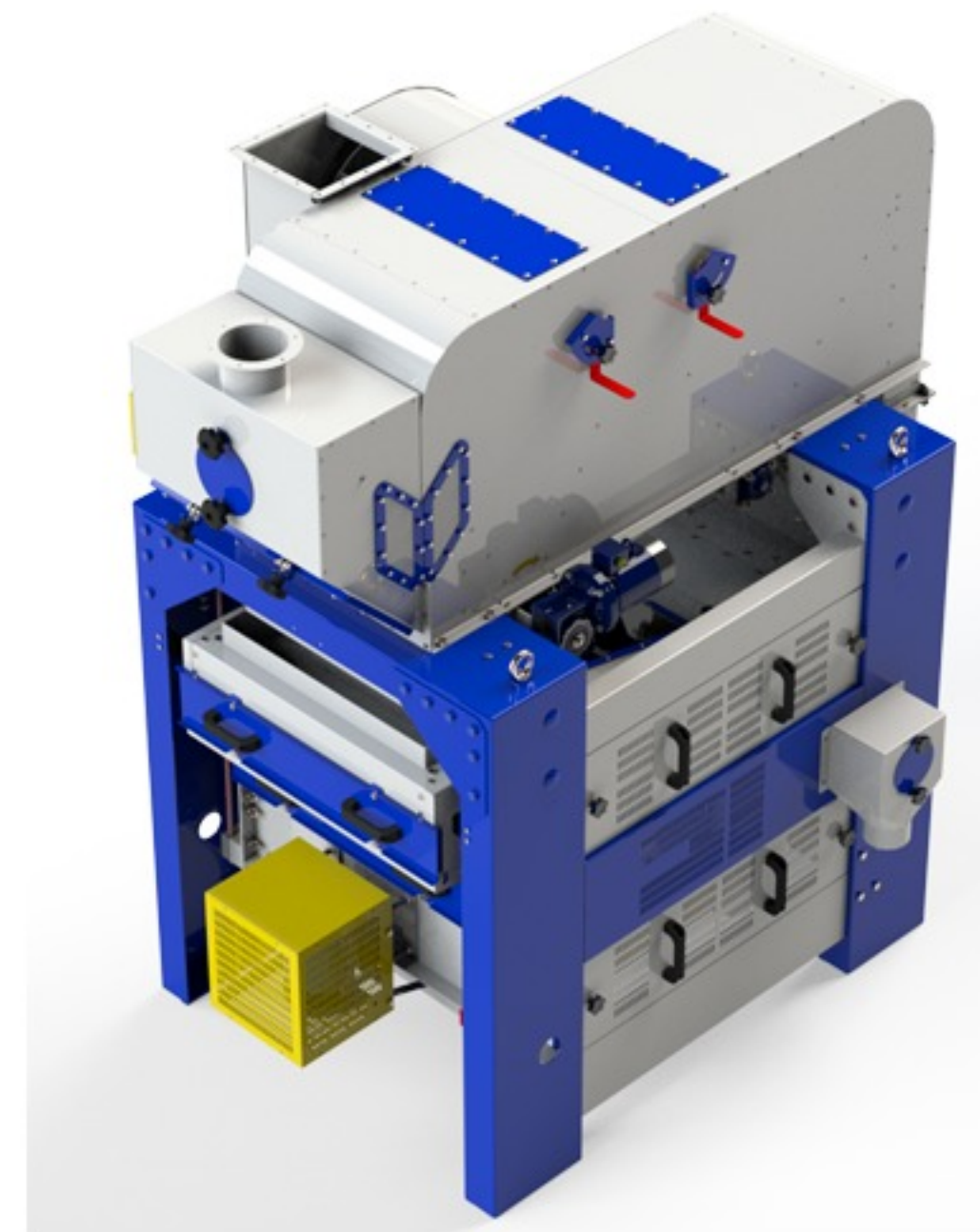

BISS + Aspiration system

MODELS BISS

| Properties | BISS 12 | BISS 25 | BISS 40 | BISS 50 | BISS 80 | BISS 200 |
|----------------------------------|---------|---------|---------|---------|---------|----------|
| During pre-cleaning, up to t/h | 13 | 27 | 42 | 52 | 80 | 200 |
| During final cleaning, up to t/h | 3.5 | 7 | 14 | 18 | 25 | 50 |
| Electricity, kWh | 0.75 | 0.75 | 1.1 | 1.1 | 1.5 | 2.95 |
| Net weight, kg | 470 | 600 | 800 | 1100 | 1300 | 3900 |
| -length, mm | 1455 | 1455 | 2070 | 1600 | 2100 | 5175 |
| -Width, mm | 1050 | 1320 | 1335 | 2450 | 2450 | 2070 |
| -Height, mm | 1365 | 1365 | 1520 | 2135 | 2135 | 3000 |

Detailed information

- Information on the BISS + Aspiration system can be found on the page - 7

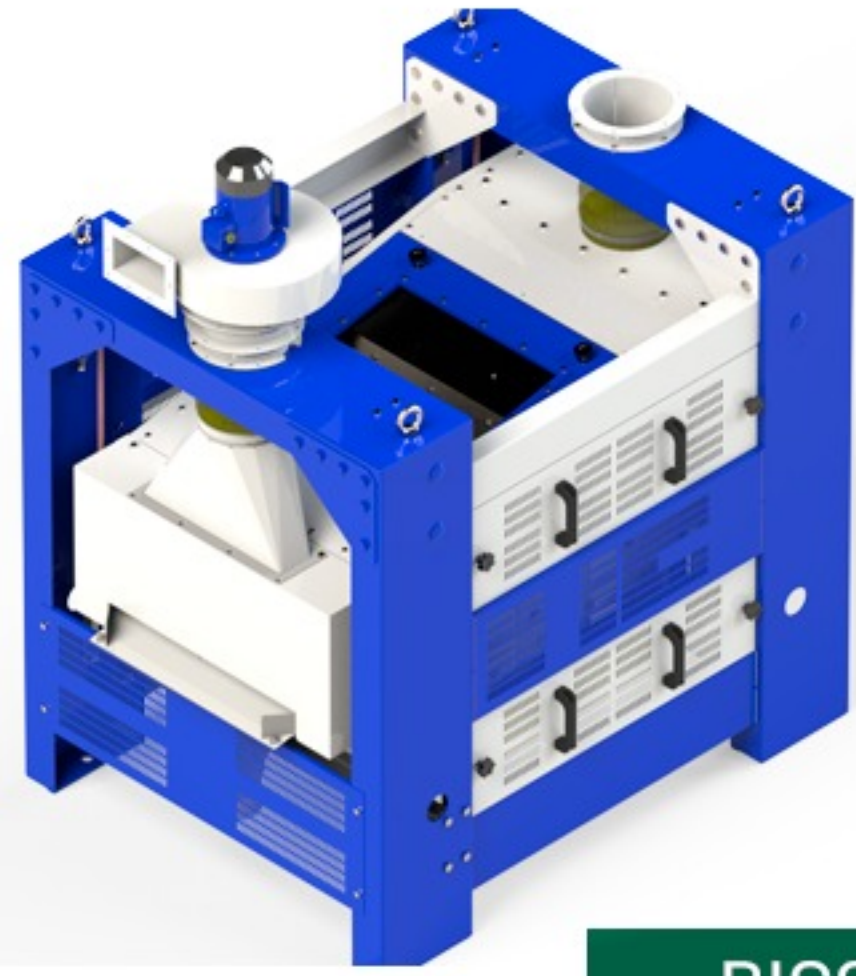

BISS 12

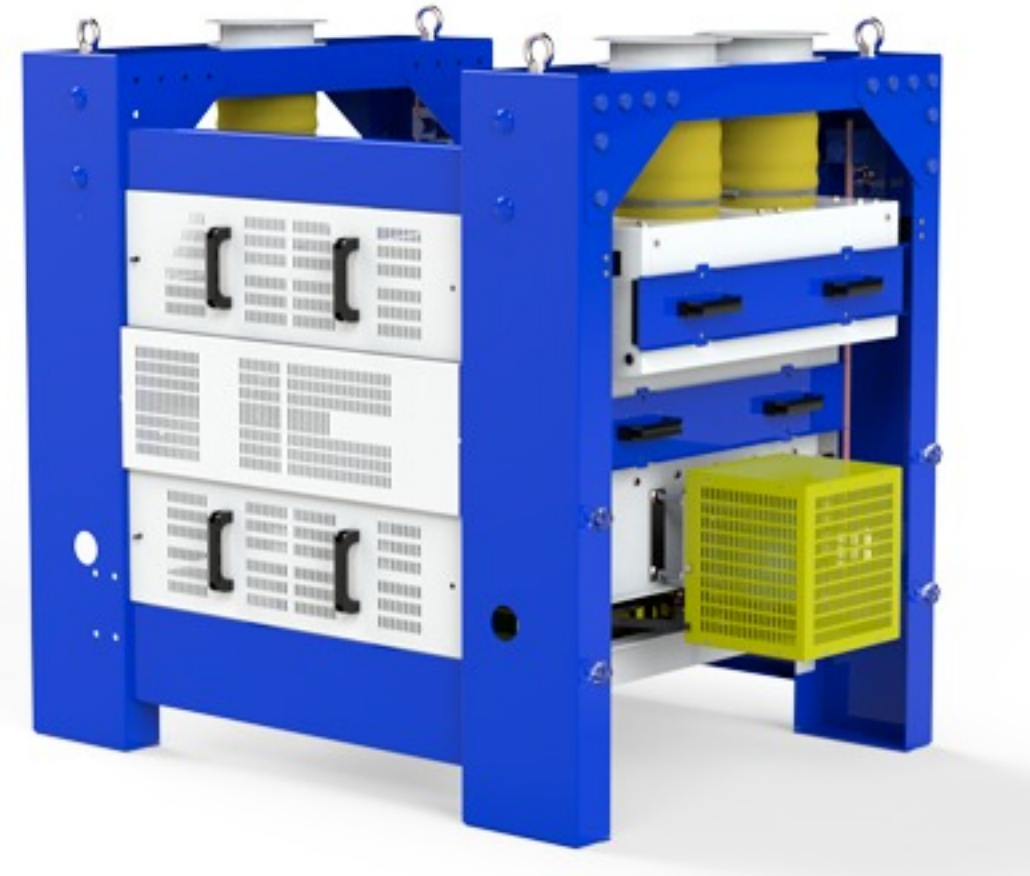

BISS 25



BISS 40



BISS 50

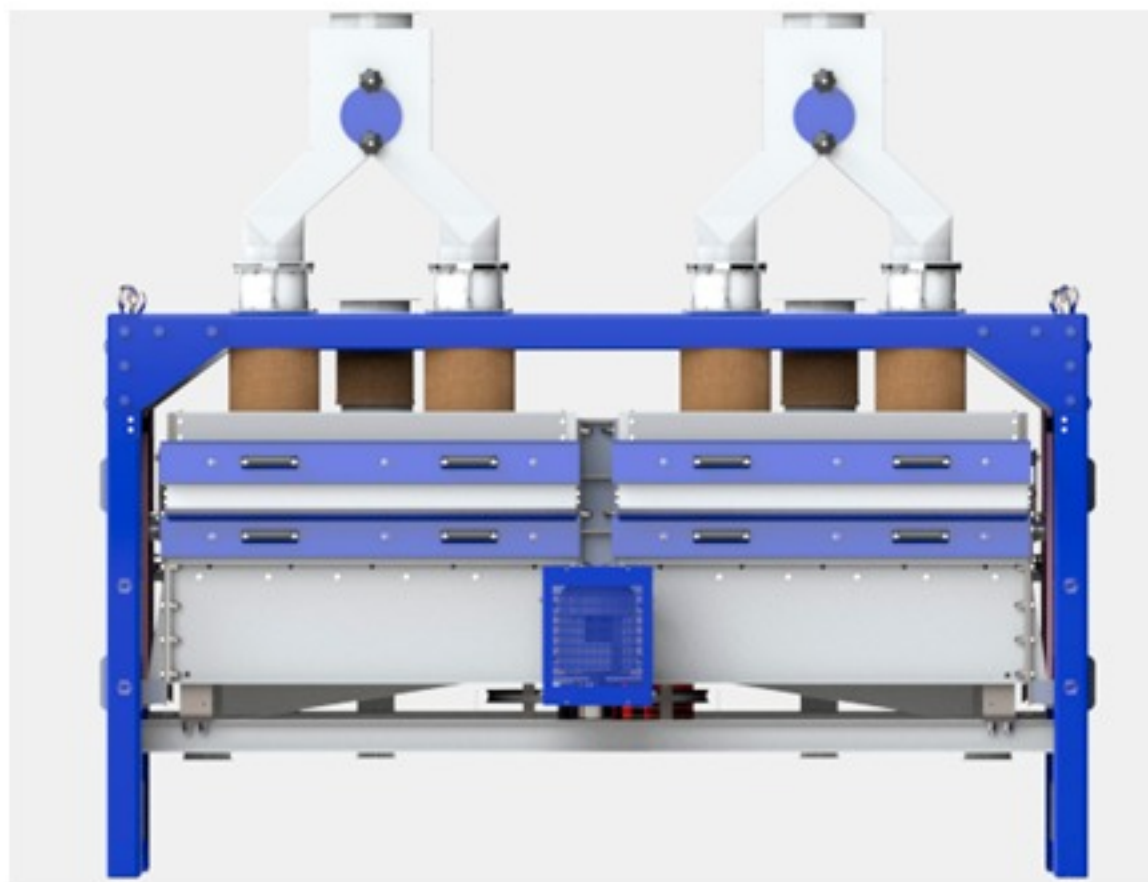

BISS 80

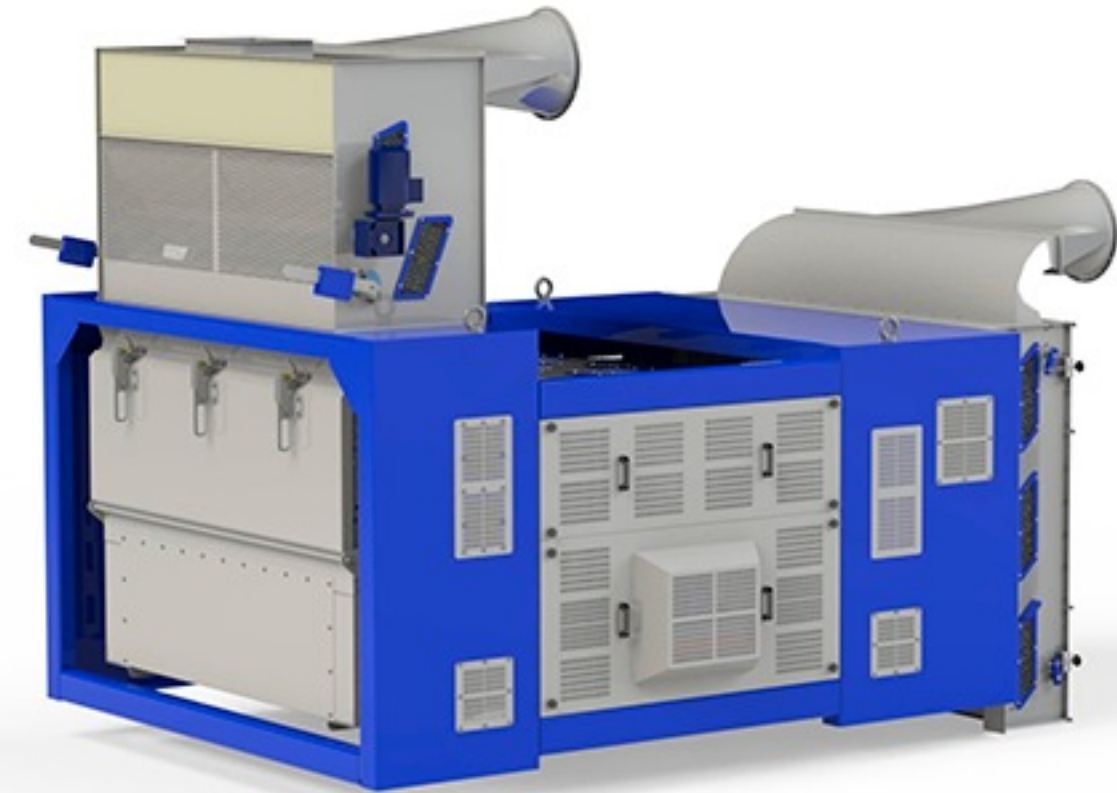

BISS 200

Sieve Grain Cleaner BISS-1 With Aspiration System

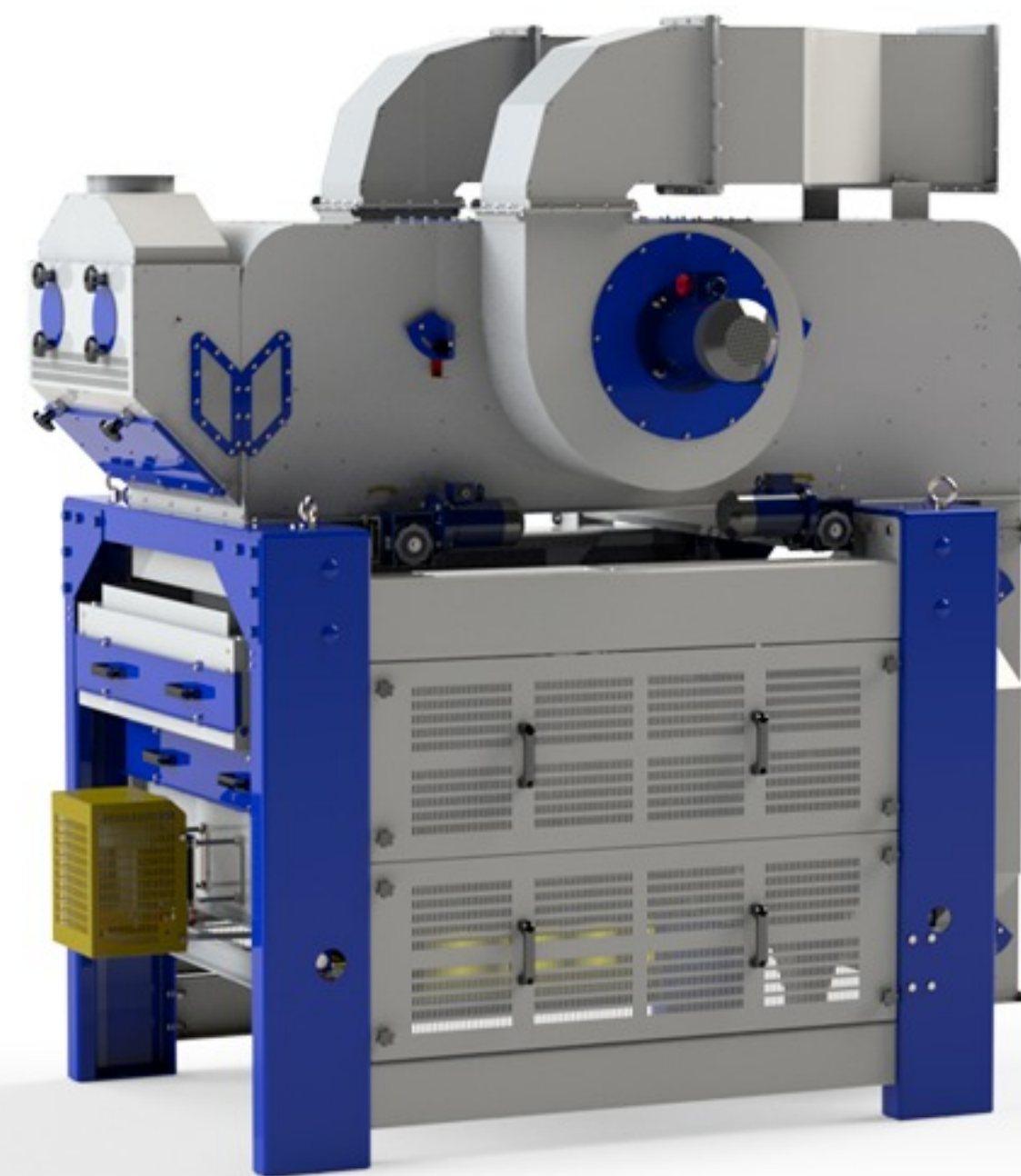

BISS comes with:

- Free sieve set on order
- Full 1-year warranty
- Data sheet with instructions

Advantages

- High cleaning performance of various Contaminants in all geometric sizes
- Magnetic trap that removes metallic impurities from the grain
- Easy change of sieves
- Easy to set up and use
- A aspiration chamber that additionally cleans the grain with air
- Grain of any purity and degree of moisture can be used for be used for cleaning

Description

The BISS -1 is equipped with a magnetic catcher and an aspiration chamber, which allows the removal of small and light impurities. The magnetic catcher allows the removal of metal particles from the grain..

Aspiration system

It enables the removal of small and light impurities both at the inlet and outlet of the separator. The model also has an integrated fan.

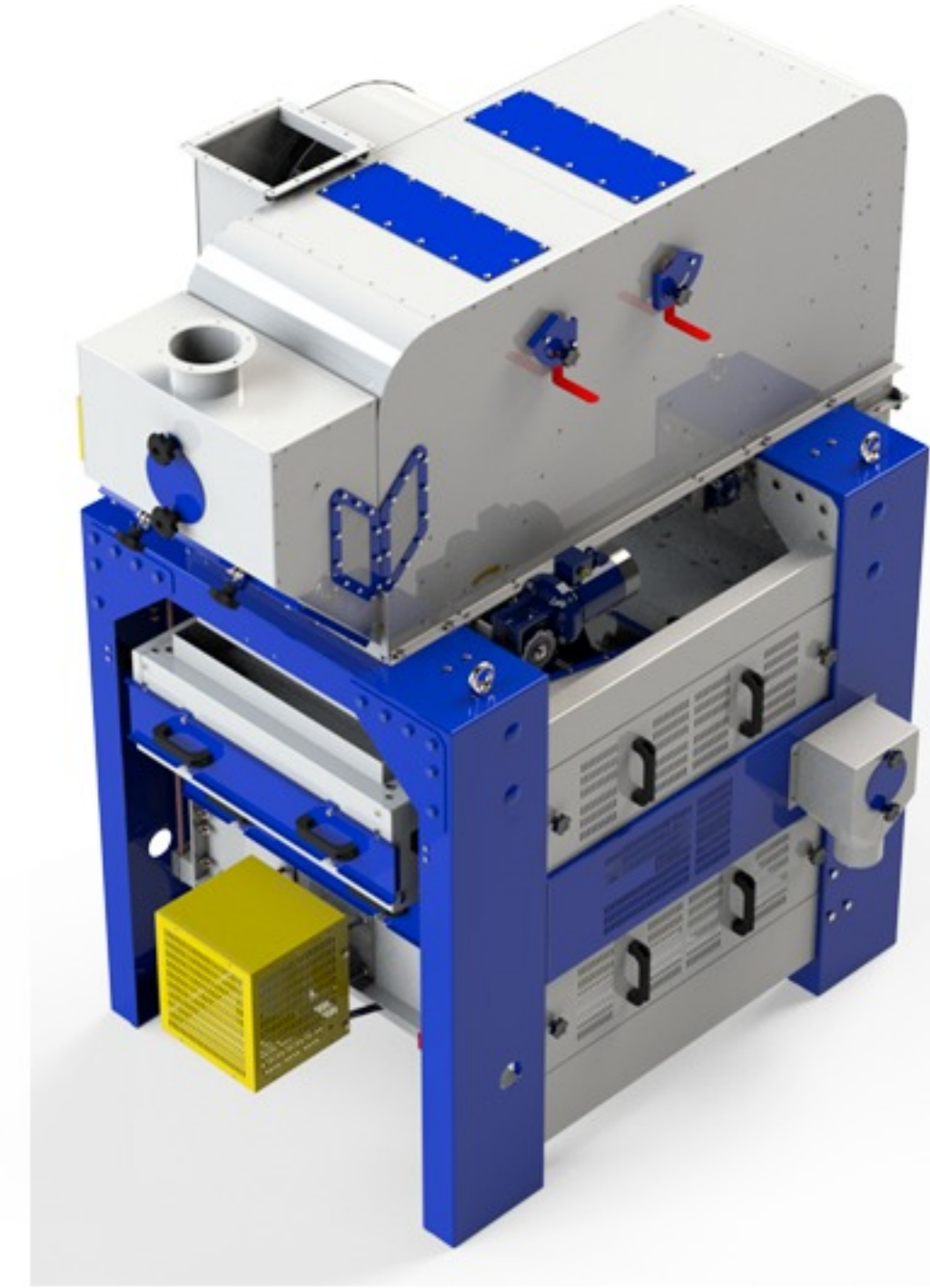
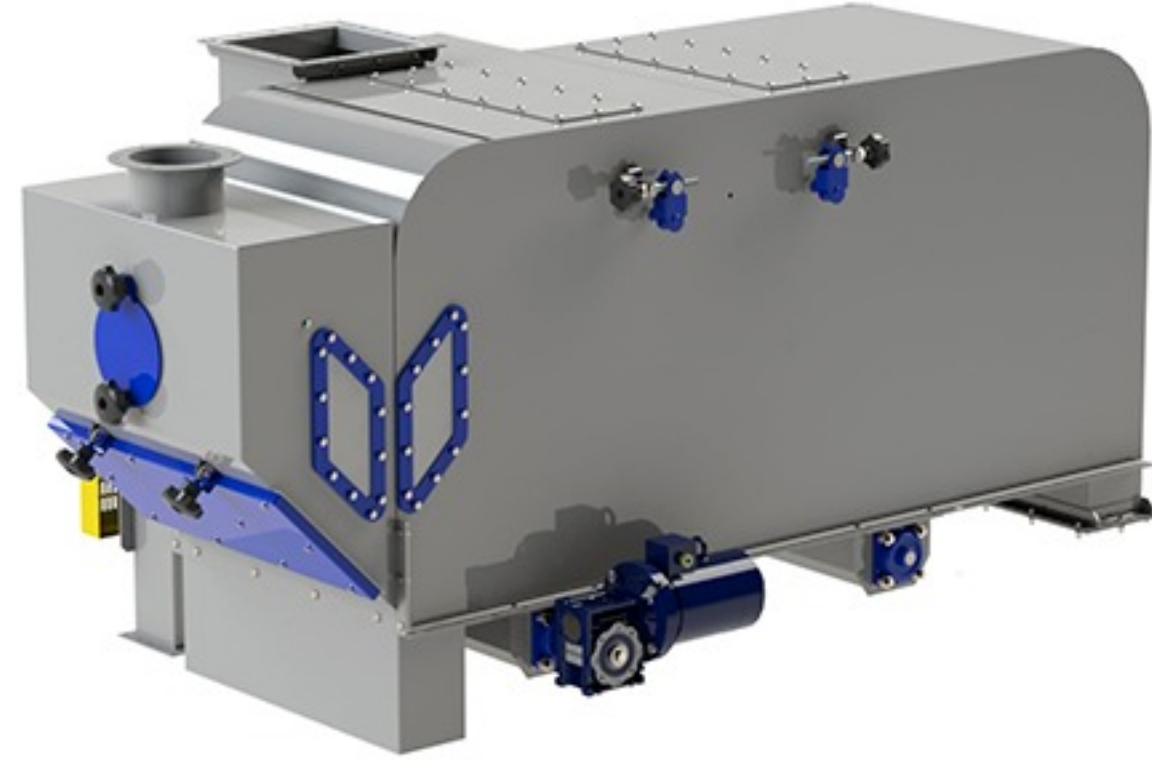

BISS-1 MODELS

| Features | BISS 12-1 | BISS 25-1 | BISS 40-1 | BISS 50-1 | BISS 80-1 |
|----------------------------------|-----------|-----------|-----------|-----------|-----------|
| During pre-cleaning, up to t/h | 13 | 27 | 42 | 52 | 80 |
| During final cleaning, up to t/h | 3.5 | 7 | 14 | 18 | 25 |
| Electricity, kWh | 3.5 | 4.3 | 7.6 | 10.25 | 10.25 |
| Net weight, kg | 700 | 1000 | 1150 | 1500 | 1700 |
| -Length, mm | 1730 | 1730 | 2278 | 2473 | 2473 |
| -Width, mm | 1450 | 1750 | 1833 | 2904 | 2904 |
| -Height, mm | 1920 | 1920 | 2400 | 2540 | 2540 |

Magnetic catcher

It catches the metal particles contained in the raw contained in the raw material, which a conventional separator may not be able to clean.

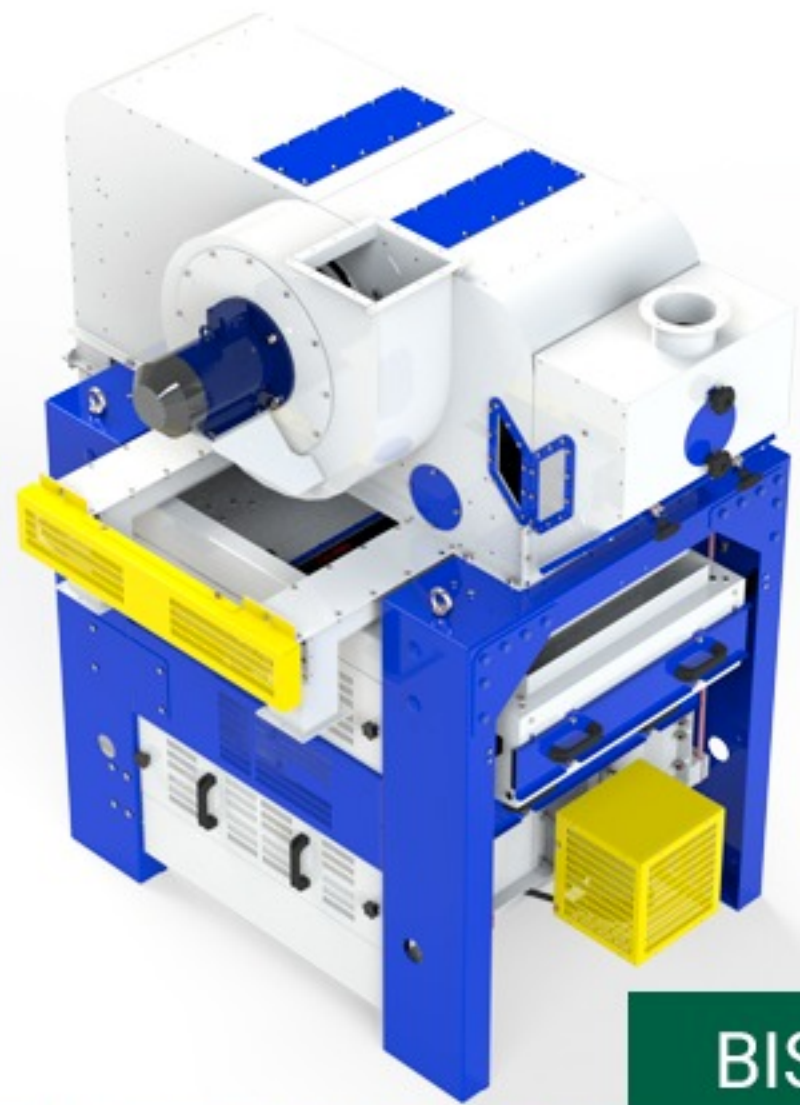

BISS 12-1

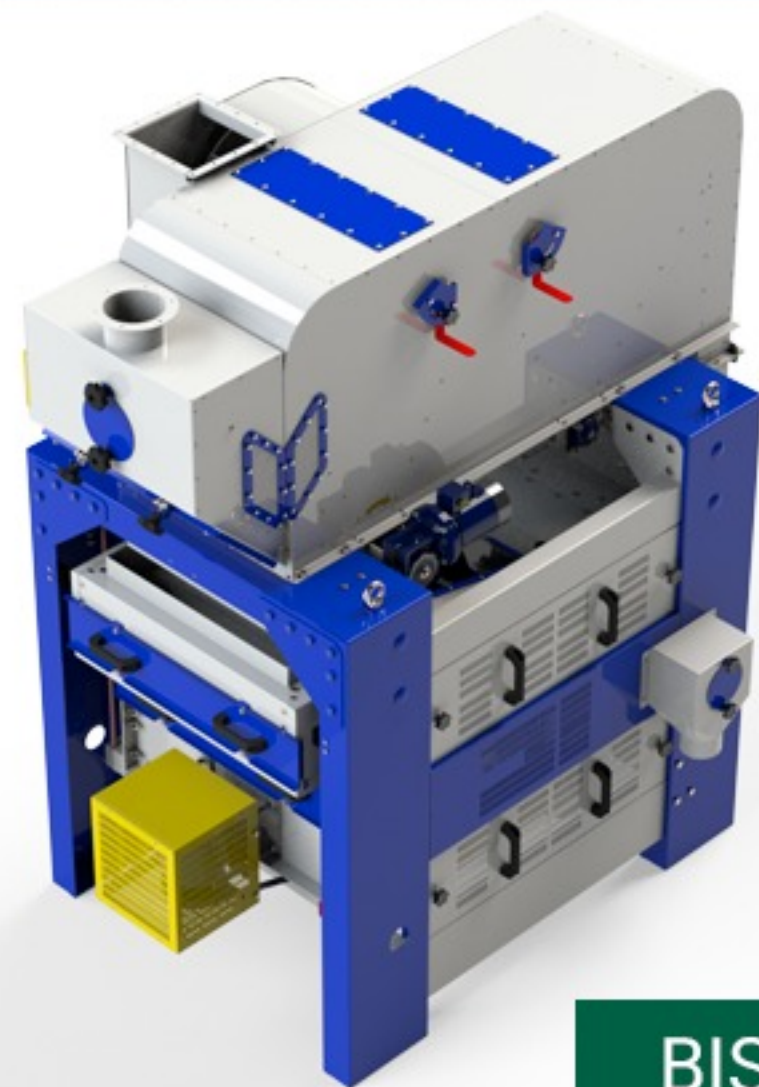

BISS 25-1



BISS 40-1



BISS 50-1



BISS 80-1

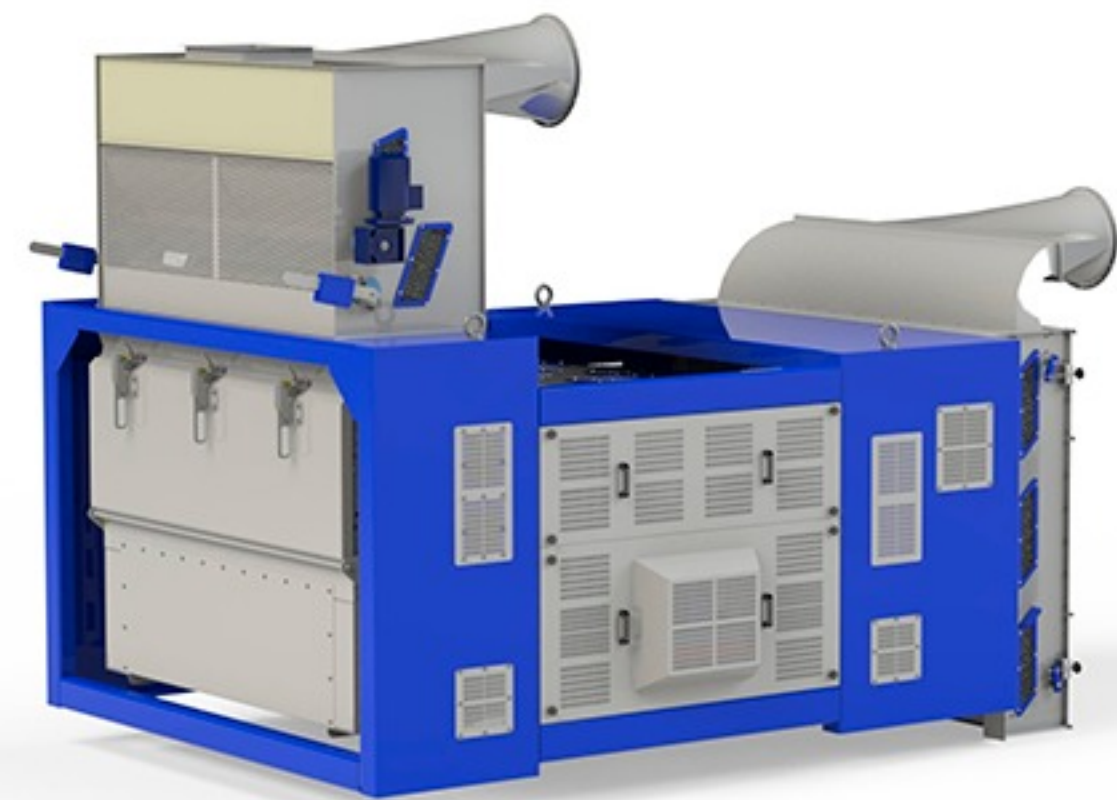

BISS 200

Drum pre-cleaner **BS 5**

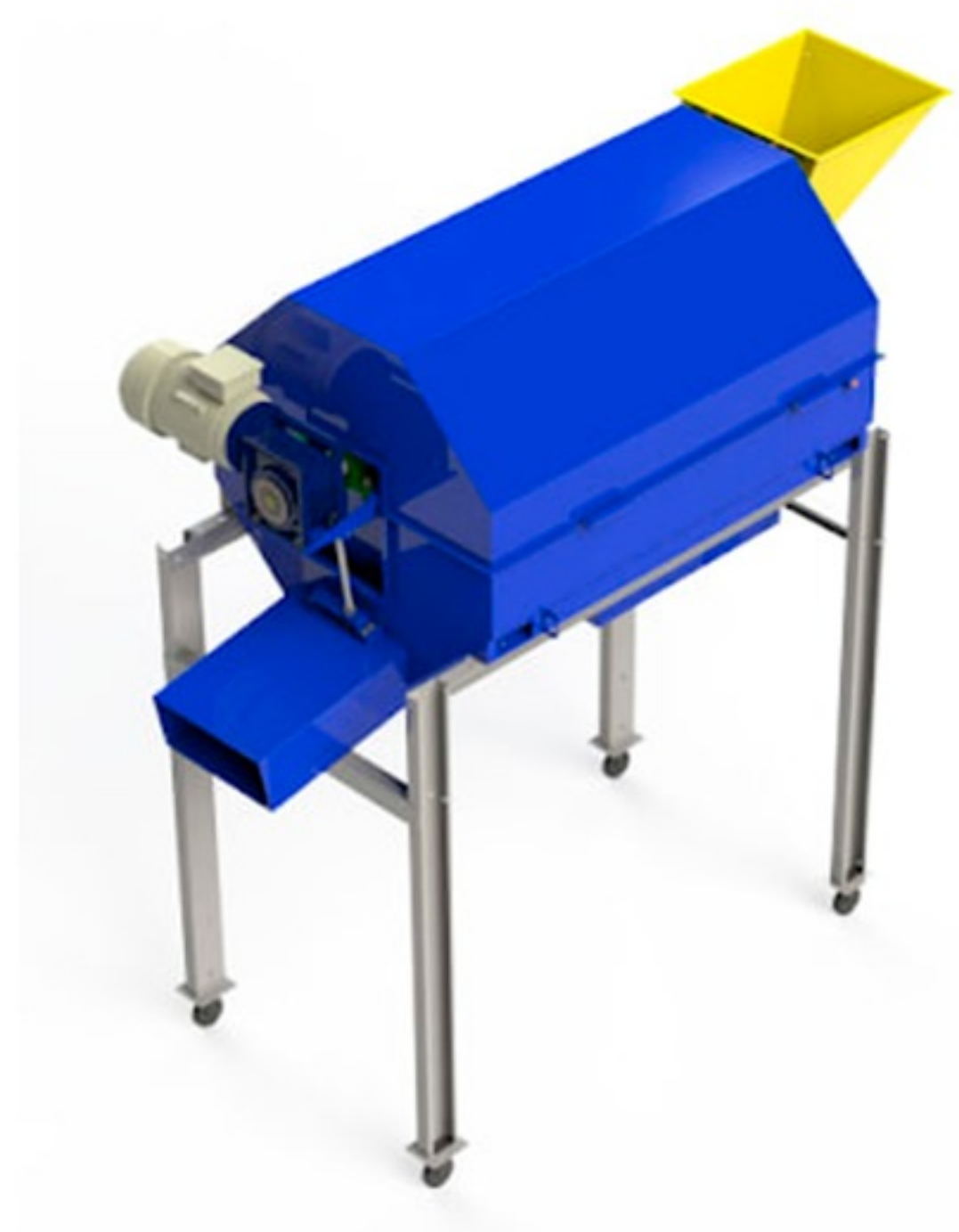

Advantages

- High coefficient of pre-cleaning from all types of impurities
- Energy saving
- Long service life due to modern manufacturing process
- Easy maintenance
- Fast amortisation

BS 5 Ideal for :

- For pre-cleaning
- Addendum to AGM

Description

The BS-5 drum separator is designed for the pre-cleaning of bulk materials from impurities. Ideal for cleaning and sorting wheat, barley, oats, millet, sunflower, maize and other cereals. A rotating drum is installed on the frame. On the loading side, the height of the drum can be adjusted via a screw and its speed can be adjusted accordingly.



Features of the **BS 5**

1. productivity - up to 5 t/h.
2. power - 0.55 kW.
3. drum diameter - 600 mm.
4. overall dimensions, mm:
 - Length: 1400
 - Width: 800
 - Height: 1000
5. weight, kg: 170.

Features of the use of BS 5

The rotating drum is placed on the frame. With an adjusting screw the angle of the drum can be adjusted. This allows you to adjust the speed, with which the grain passes through the drum sieve. Only one sieve is supplied. As an option, several sieves can be ordered for different crops

Sieve Grain Cleaner UKS



UKS comes with:

- Free sieve set on order
- Full 1-year warranty
- Data sheet with instructions

Advantages

- Cleaning and calibration independent of the Degree of moisture and contamination of the grain
- Energy saving
- Easy change of sieves
- Easy to set up and use
- Long service life due to modern manufacturing process
- Grain of any purity and degree of moisture can be used for be used for cleaning

Description

The UKS is a modern sieve grain cleaner with a cleaning capacity of from 600 kg to 3000 kg/h. The grain cleaner is used for cleaning and calibration of grain with a grain size of 0.8 to 15 mm, regardless of the grain's degree of moisture and contamination. The sieve is cleaned with brushes.



UKS 0.6

1. capacity, kg: up to 600
3. installed main engine power, kW: 0.55
4. overall dimensions, mm:
 - Length: 1350
 - Width: 1000
 - Height: 1800
5. weight, kg: 170.

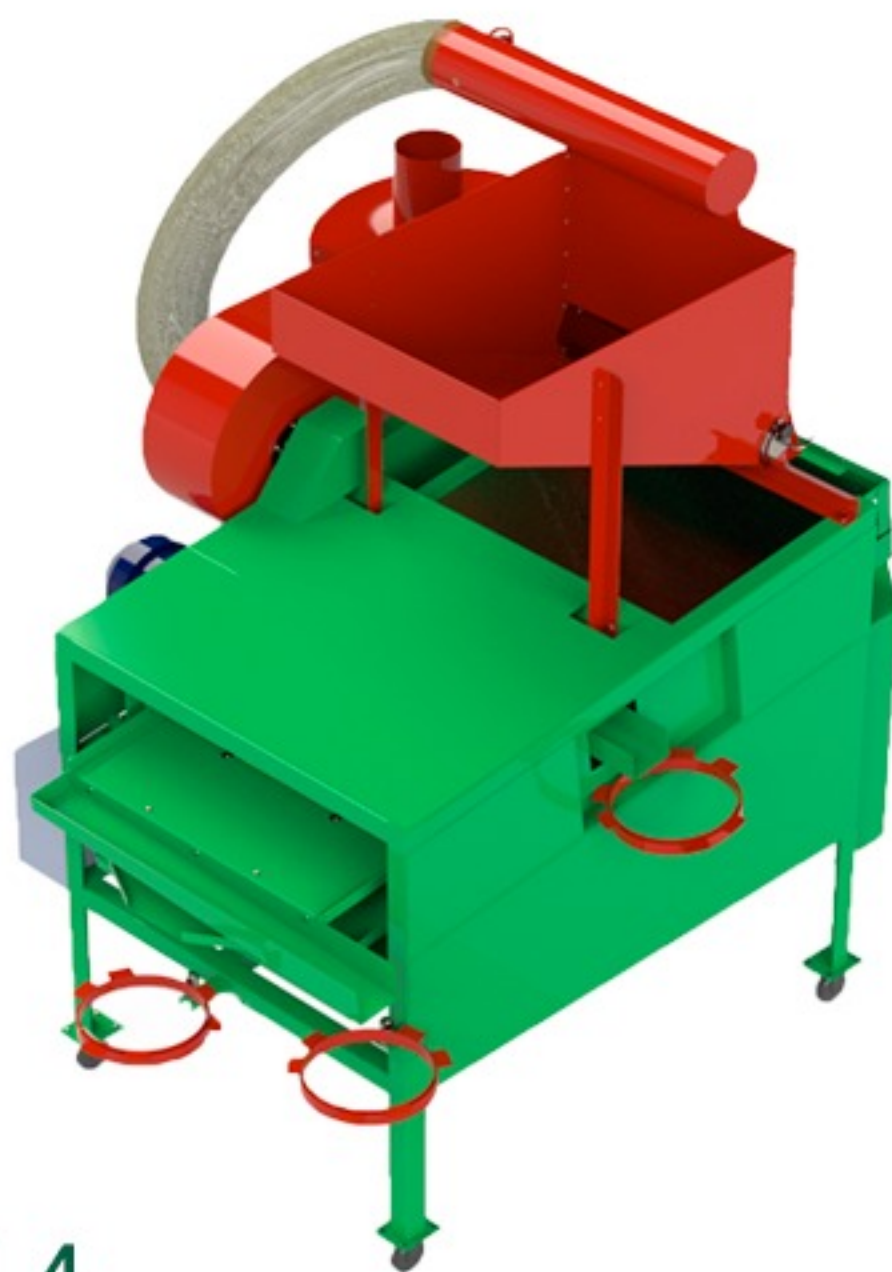

UKS 1.4

1. capacity, kg: up to 1400
3. installed main engine power, kW: 1.1
4. overall dimensions, mm:
 - Length: 1950
 - Width: 1550
 - Height, 2150
5. weight, kg: 310.

Intake system: aspiration system

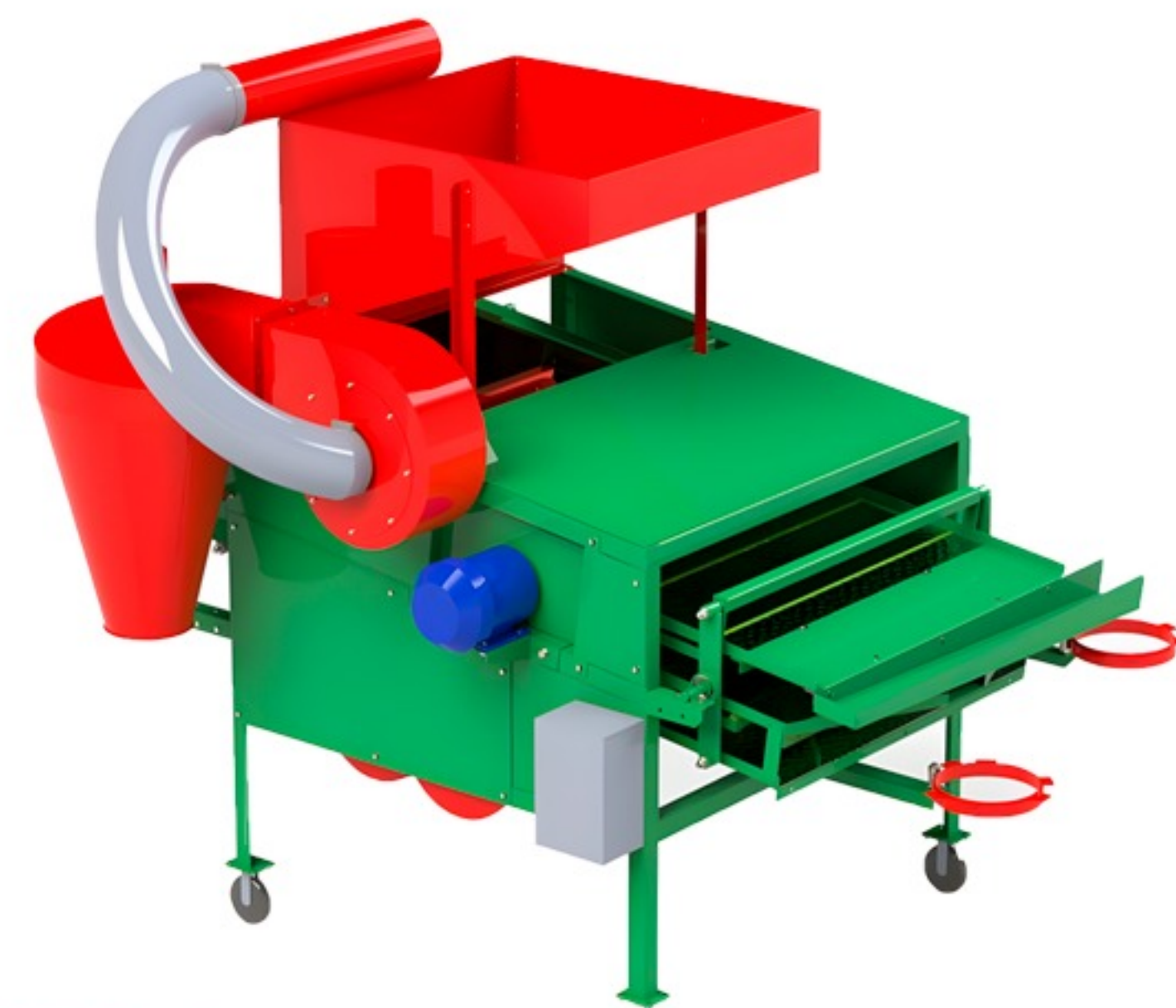

UKS 3.0

1. capacity, kg: up to 3000
3. installed main engine power, kW: 2.2
4. overall dimensions, mm:
 - Length: 2450
 - Width: 1900
 - Height, 2150
5. weight, kg: 390.

Intake system: aspiration system

Drum Grain Cleaner **BS**

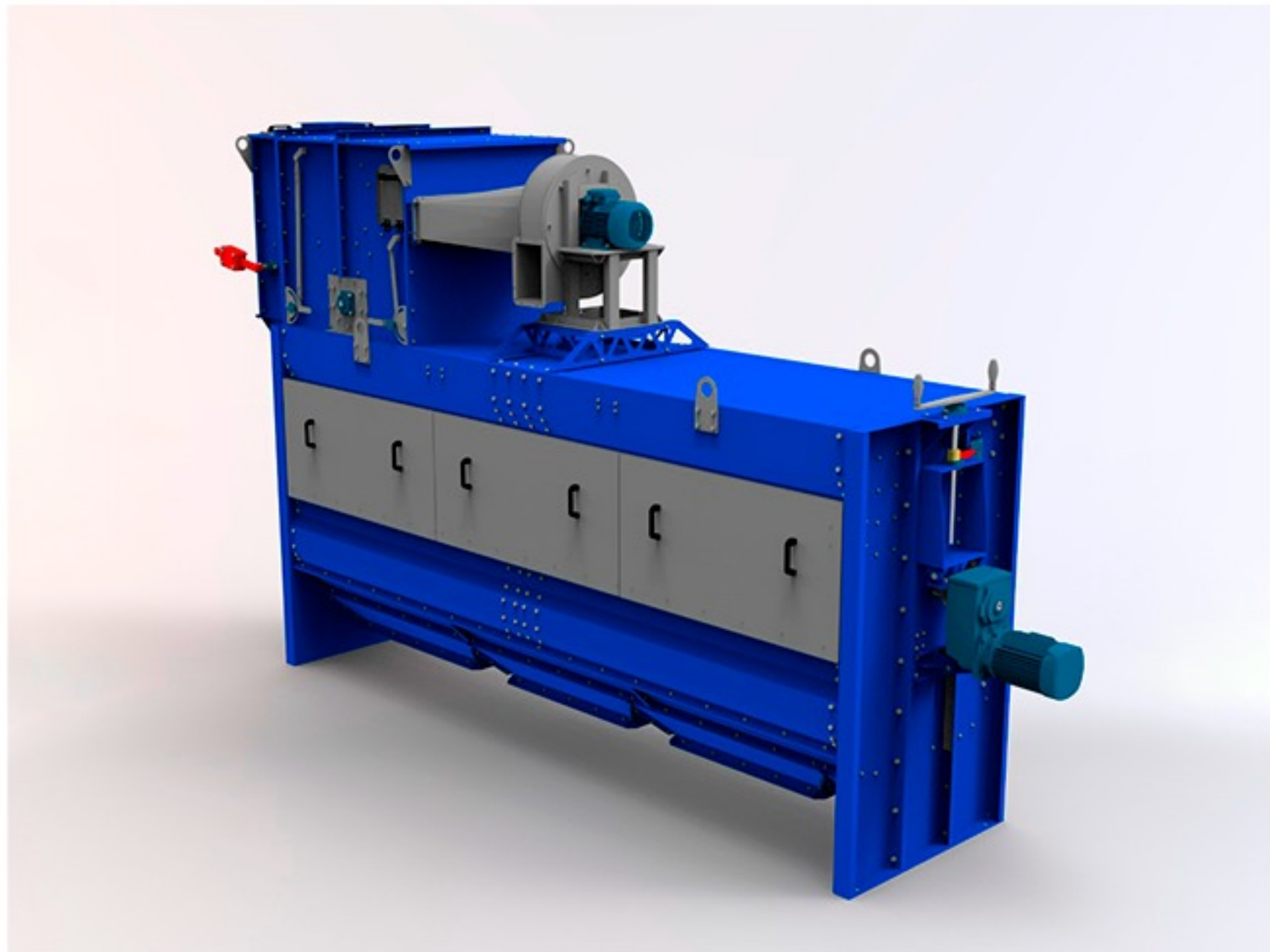

BS is ideal for

- Cereals;
- Legumes;
- Technical crops;
- Oilseeds.

The BS drum separator performs the following functions:

1. pre-cleaning
2. primary treatment
3. secondary cleaning
4. sorting
5. calibration

Description

The BS-200 drum separator is designed for cleaning bulk materials from impurities and separating them into fractions. It is ideal for cleaning and sorting wheat, barley, oats, millet, sunflower, maize, etc. A rotating drum is installed on the frame.

On the feeding side, the drum can be adjusted in height via an adjusting screw and its speed can be adjusted accordingly. The set includes one sieve.

Optionally, several sieves for different crops can be ordered.



MODELS BS

| | BS 30 | BS 50 | BS 75 | BS 100 | BS 200 |
|--------------------|-------|-------|-------|--------|--------|
| Capacity, t/h | 30 | 50 | 75 | 100 | 200 |
| Drum diameter, mm | 600 | 900 | 900 | 1280 | 1600 |
| Number of sieves | 3 | 3 | 4 | 4 | 4 |
| Total screen area | 5.5 | 7.5 | 10 | 12 | 20 |
| Drum drive power | 2.2 | 2.2 | 3 | 4 | 7.5 |
| Fan drive capacity | 3.75 | 4 | 4 | 7.5 | 11 |
| Net weight | 1300 | 1400 | 1600 | 2300 | 3500 |
| -Length | 4410 | 5700 | 5800 | 5600 | 6800 |
| -Width | 1100 | 1800 | 1800 | 2200 | 3000 |
| -Height | 2810 | 3000 | 3000 | 3400 | 4500 |

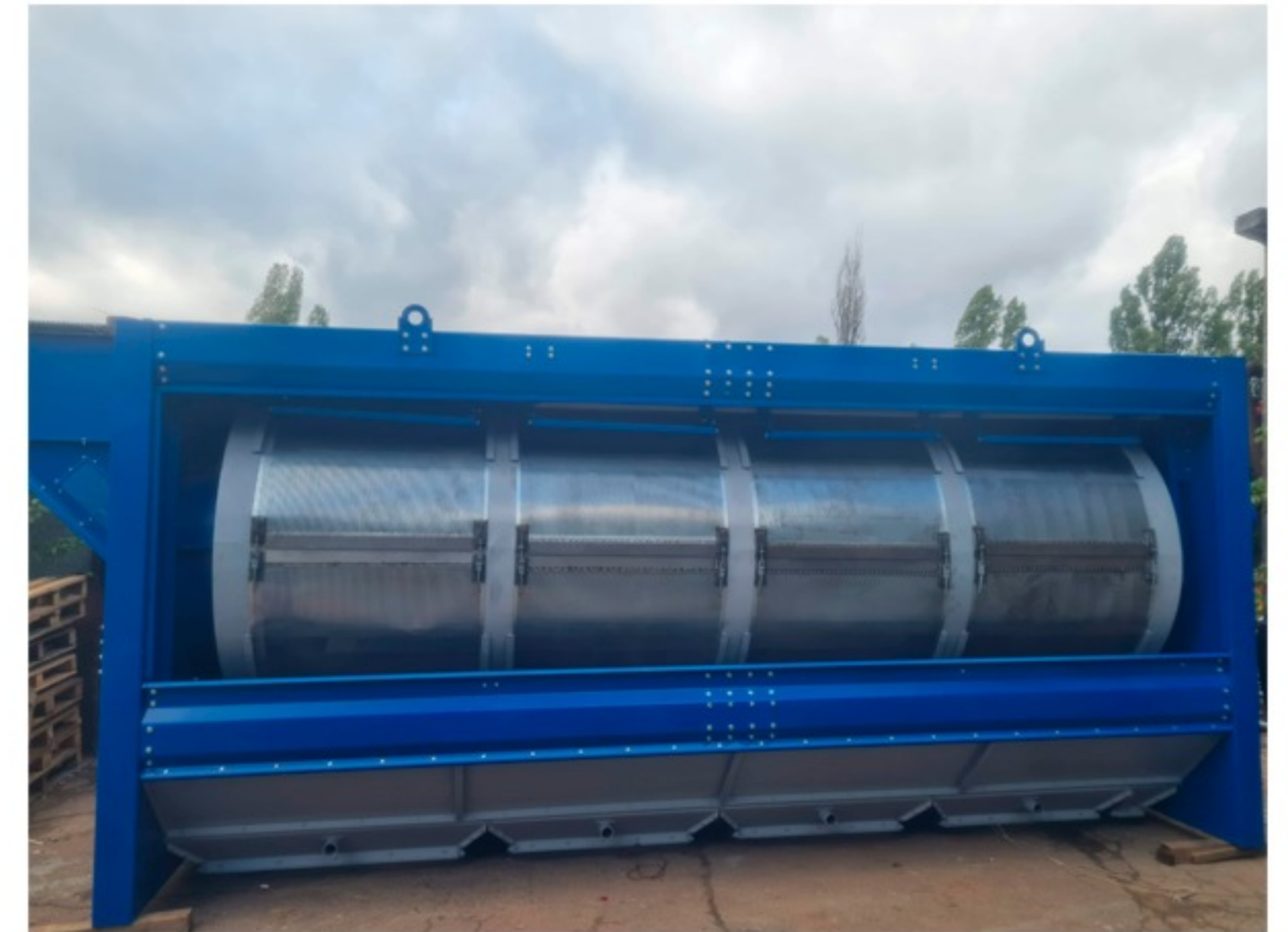

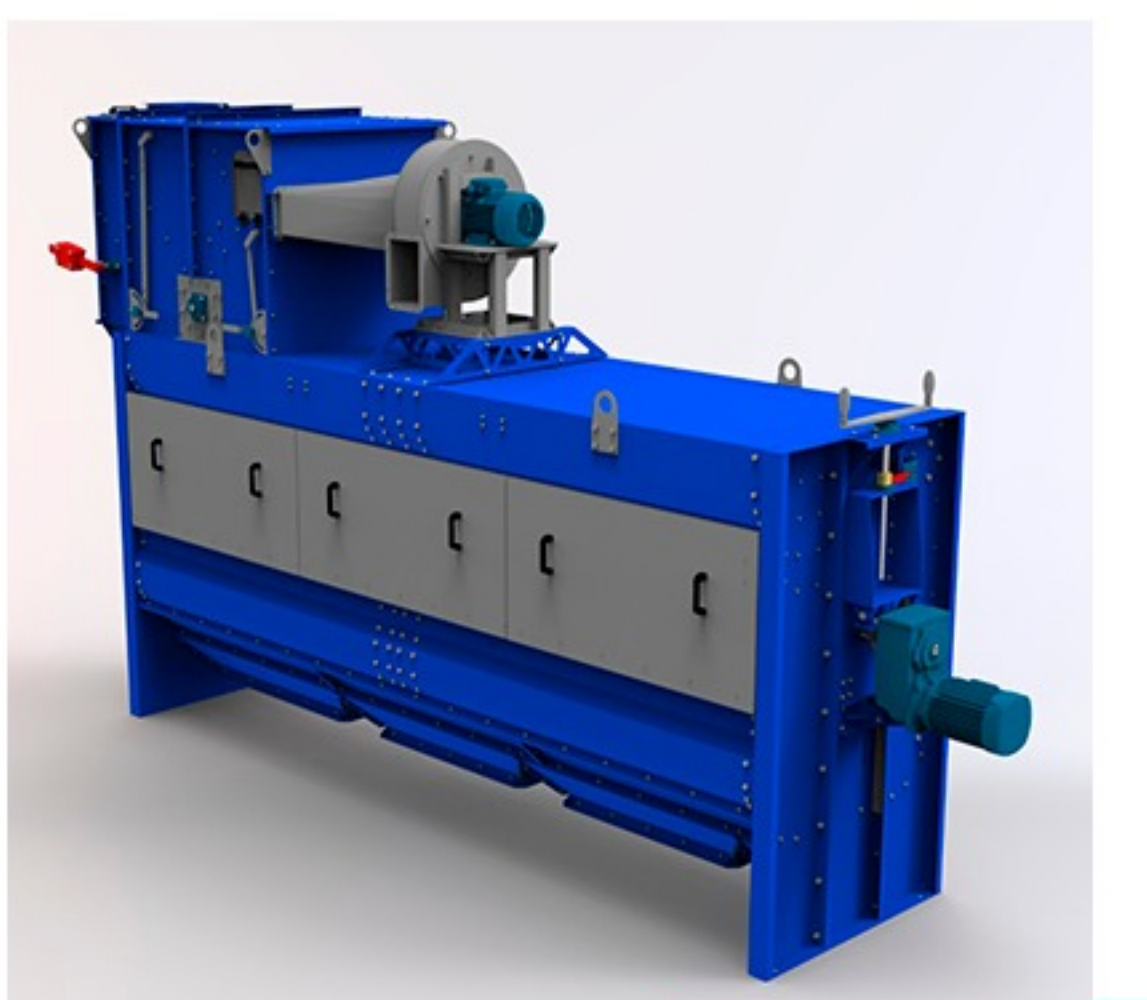

BS 30

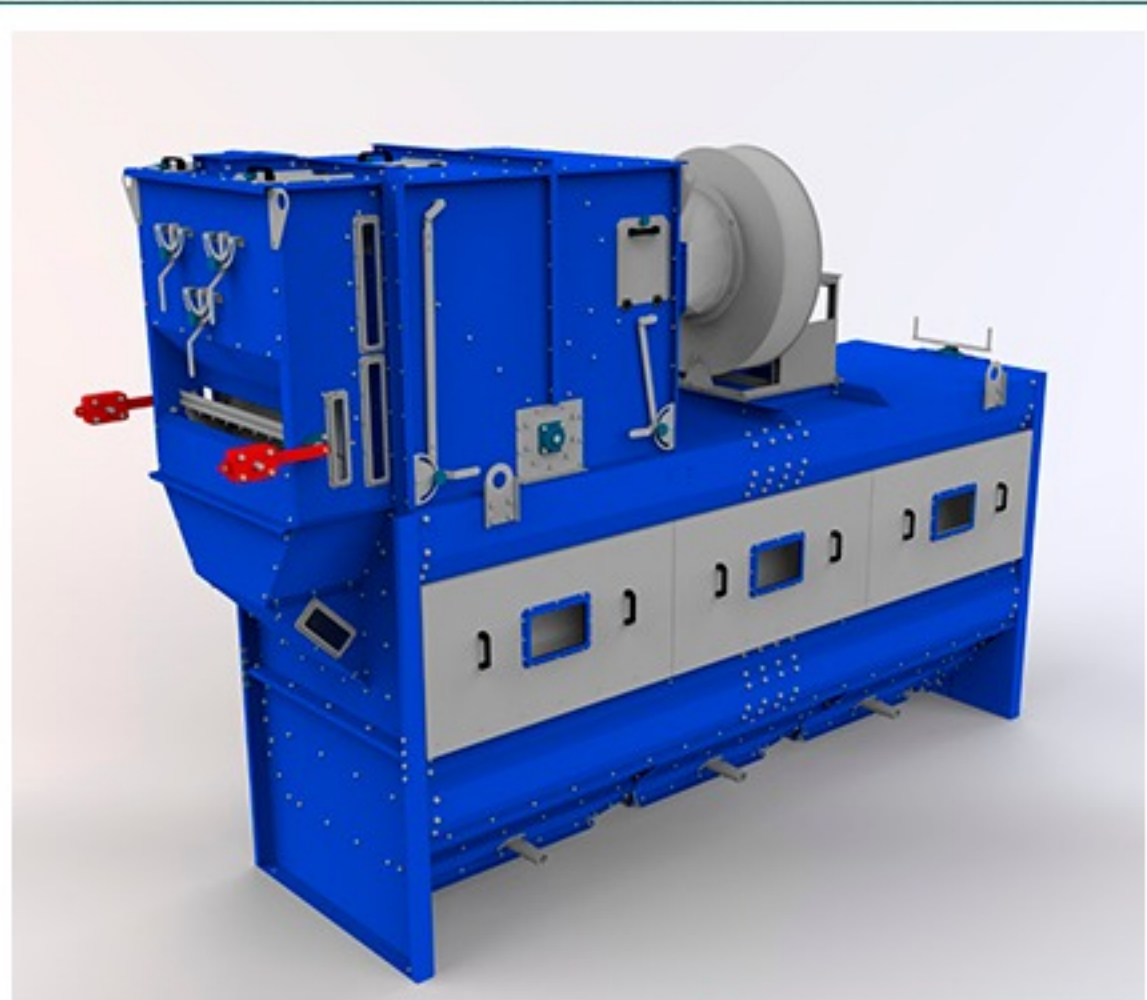

BS 50

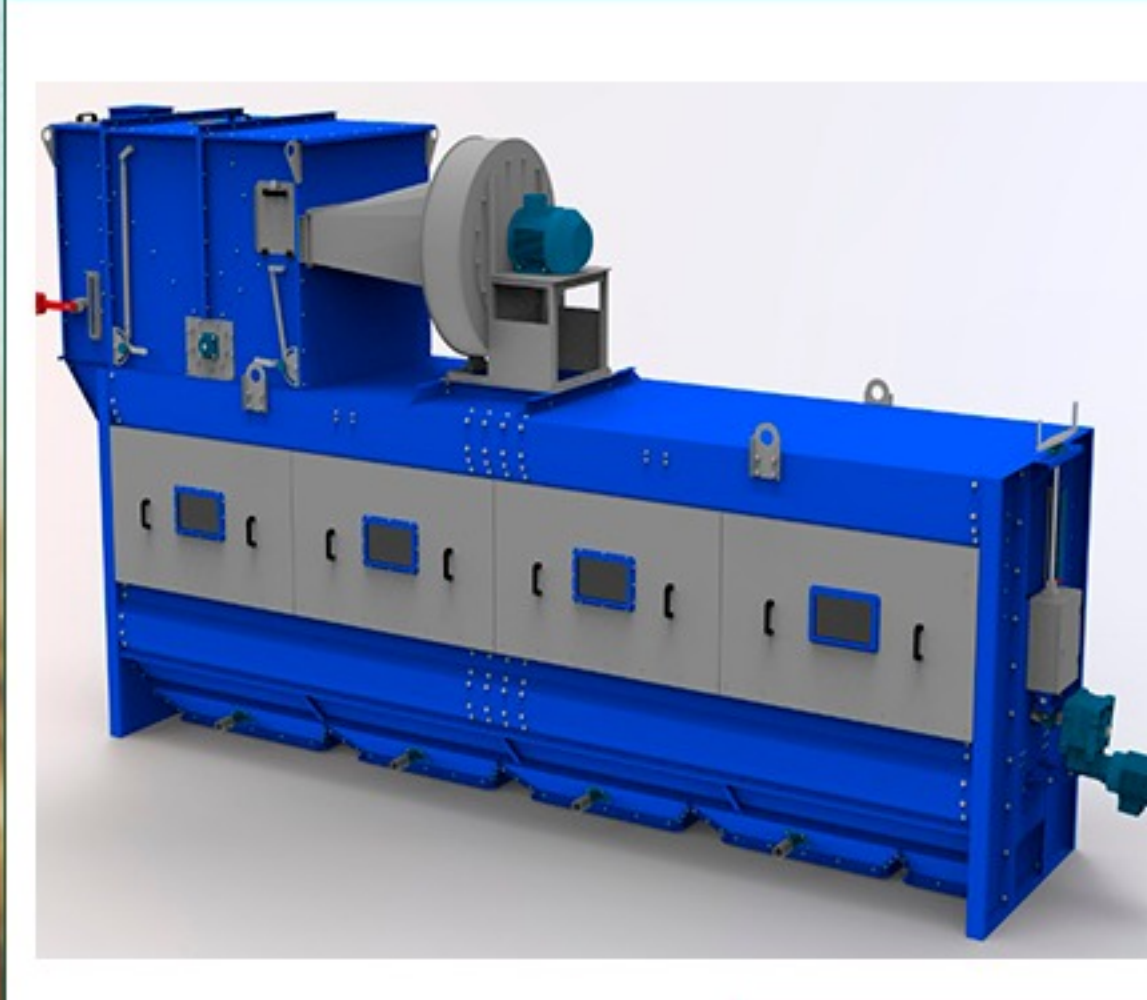

BS 75

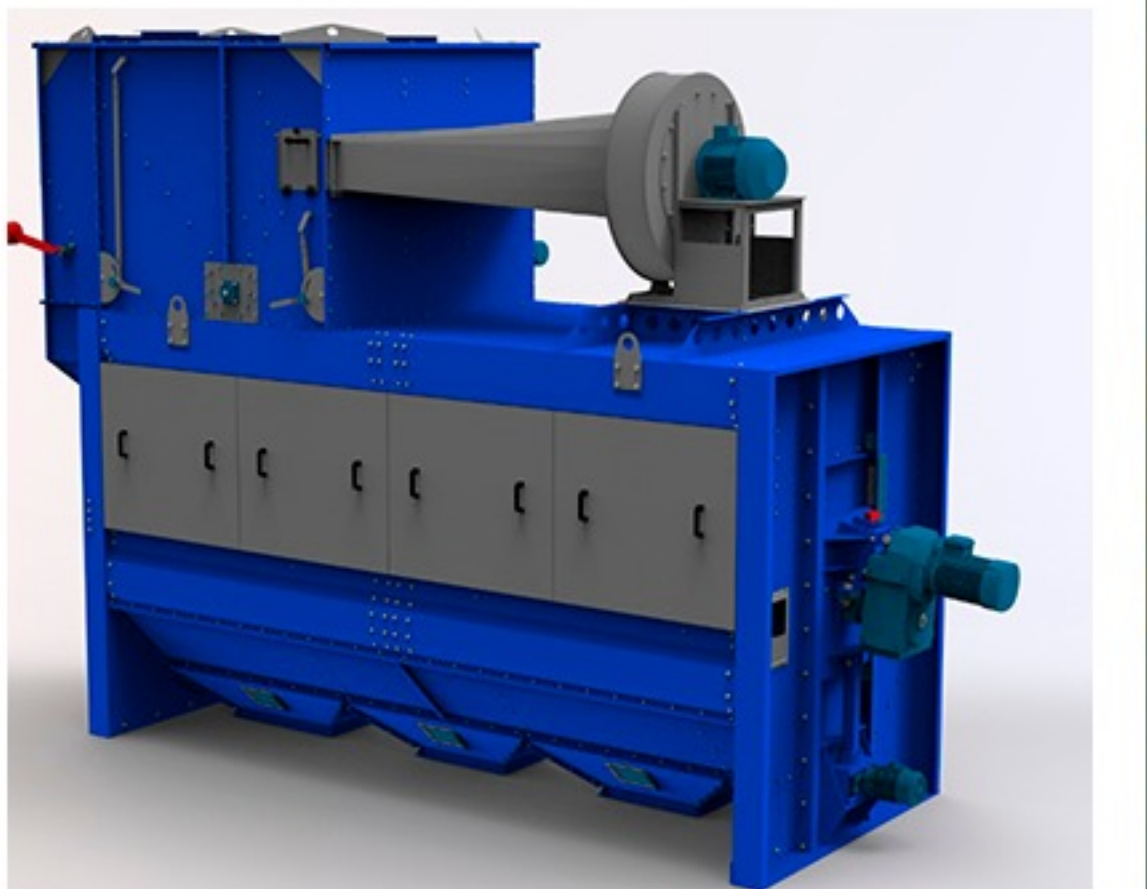

BS 100

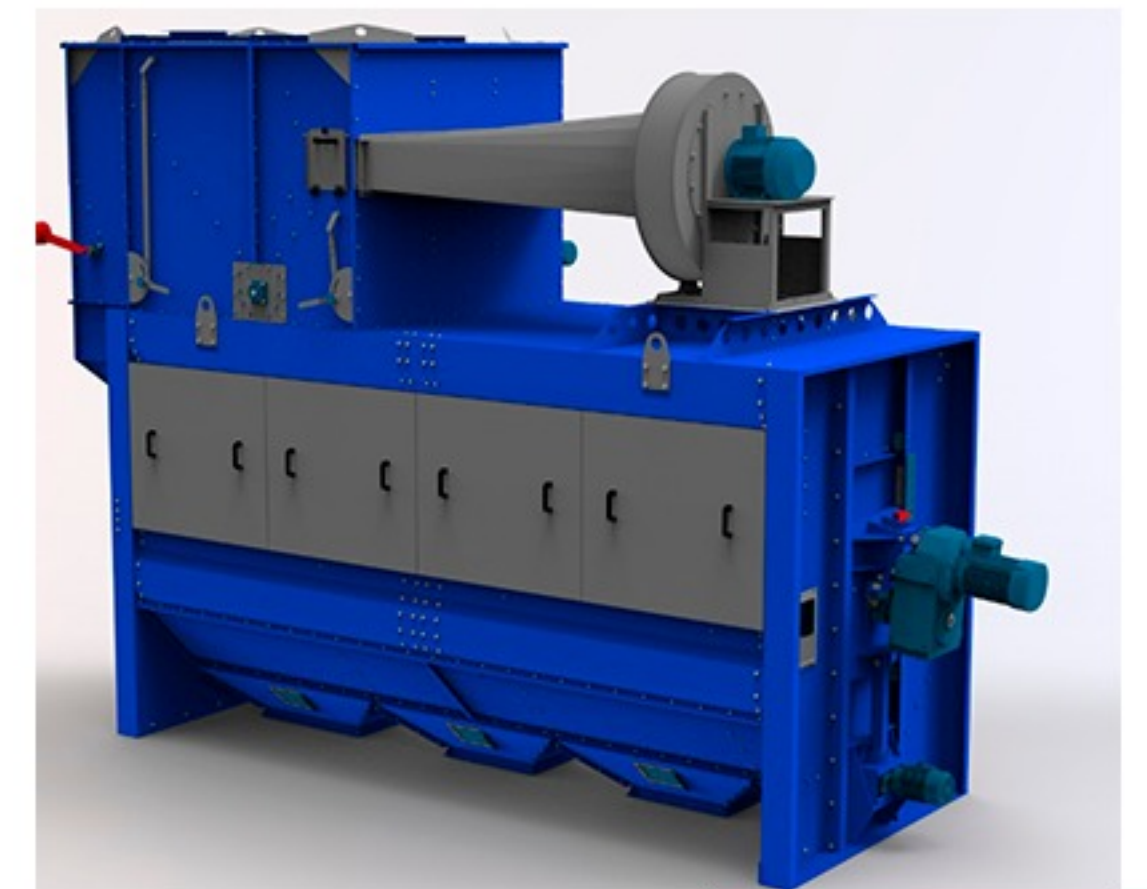

BS 150

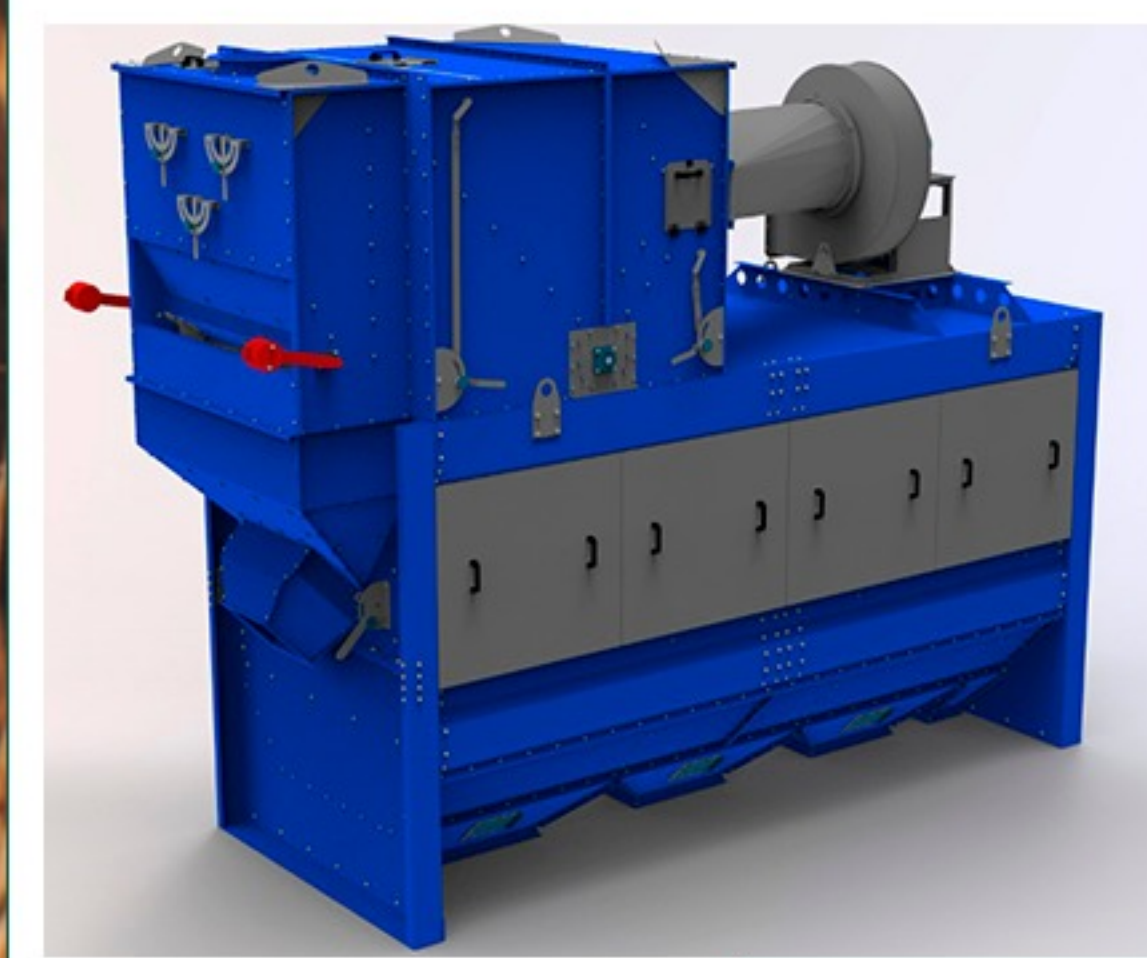

BS 200

Grain cleaner Gravity table WT



Description

The gravity table is another type of grain cleaner and is used to sort grains of the same size but different weights. The purity level reaches a very high level, ensuring excellent grain quality.



MODELS WT

| Properties | WT 0.3 | WT 1.0 | WT 1.5 | WT 2.0 | WT 5.0 | WT 10.0 |
|------------------------------|--------|--------|--------|--------|--------|---------|
| Capacity, up to t/h | 0.3 | 1 | 1.5 | 2 | 5 | 10 |
| Electricity consumption, kWh | 1.12 | 5.15 | 5.50 | 7.30 | 14.7 | 20.1 |
| Net weight, kg | 136 | 400 | 740 | 850 | 1510 | 1800 |
| -length, mm | 1000 | 1900 | 1700 | 2300 | 2600 | 3100 |
| -Width, mm | 850 | 1150 | 1520 | 1210 | 1800 | 2500 |
| -Height, mm | 1240 | 1950 | 1350 | 2600 | 1650 | 2550 |

Seed dressing machine PN



Advantages

- Mobile
- High performance
- Easy to move around the warehouse
- Easy change of location at the current site
- Long service life thanks to modern production process
- Short payback period

Description

It features precise and uniform liquid delivery over a wide range of delivery speeds and gentle seed mixing. of delivery speeds as well as gentle seed mixing. The extended auger ensures higher quality and even distribution of the dressing. The loading can be manual or mechanical. The grain tank is only 60 cm high and is easy to load. loaded. The disinfectant is automatically mixed with the water in the machine's tank. A basket filter is installed in the neck of the tank to prevent solid particles from entering. The treated seed can be unloaded into bags, big bags or onto the bed of a truck.

PN 3



Features for 3 t/h:

1. capacity, t/h - 1-3
2. tank capacity, l - 50
3. discharge from the column, l/min - 0.160-2
4. power, kW - 0.75 (380 V/220 V)
5. weight, kg - 80

PN 5



Features for 5 t/h:

1. capacity, t/h - 1-5
2. tank capacity - 50 l
3. power kW - 1.1/1.5 (380 V/220 V)
4. unloading height - 80 cm to 2.40 m
5. weight, kg - 130

Seed dressing machine PN 14-2

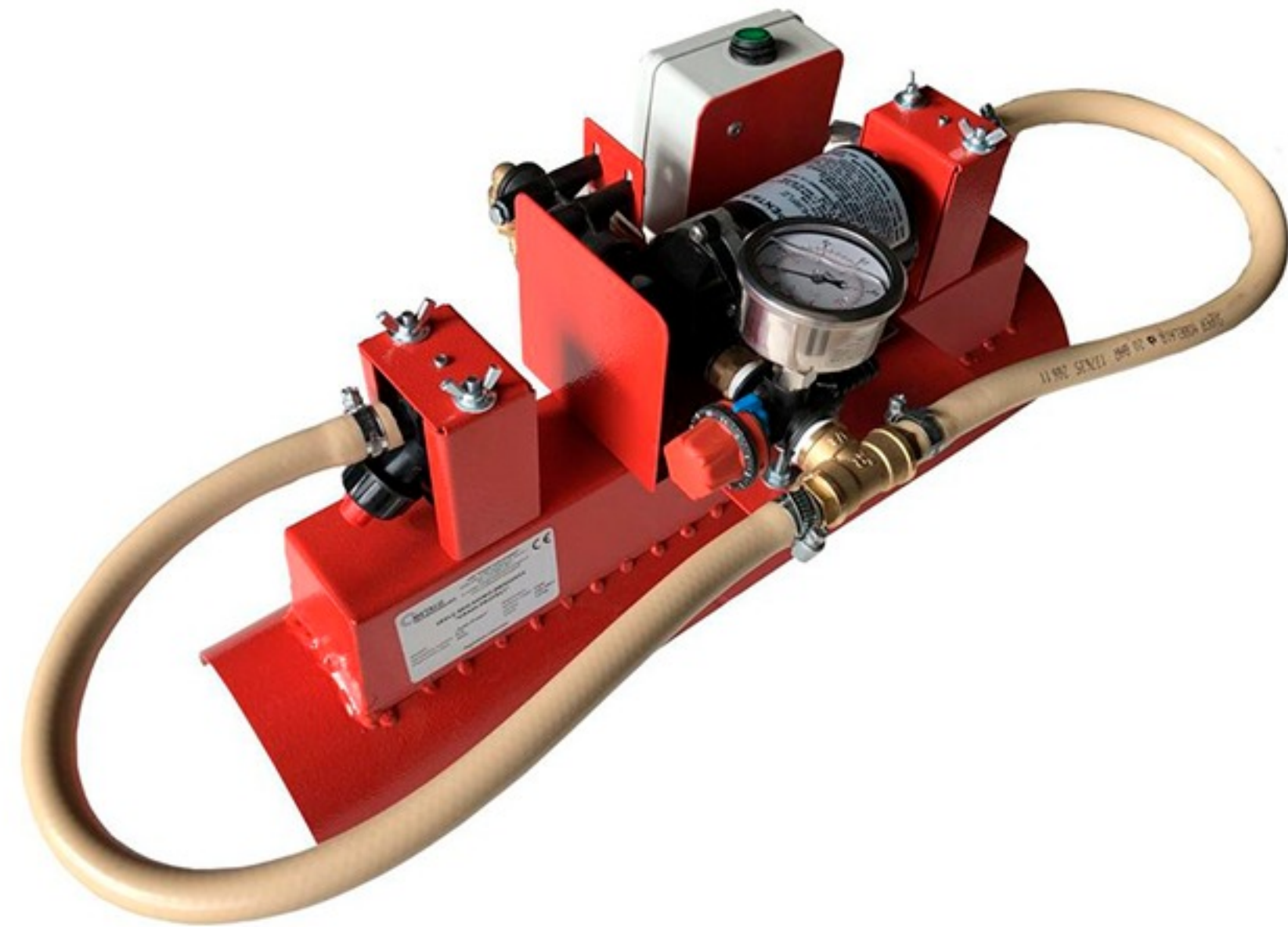

Description

The seed wrapper is designed for precise and high quality wrapping of seeds with special preparations before sowing. with special preparations before sowing to protect the germinating crops from diseases. from diseases. The device is mounted on a grain auger conveyor and with its and with its help a high quality mixing and grain collection takes place according to the specific the specified amount of liquid recommended by the drug manufacturers. The unit is equipped with two nozzles that spray a different amount of liquid as the pressure increases or decreases. the exact amount of liquid specified on the additional nozzle. The set consists of 4 nozzles that can be interchanged to use different solutions and coatings in small and large quantities. and coatings in small and large quantities.

Features PN 14-2



- Utility of the unit - up to 14 t/h
- Number of nozzles - 2 pieces
- Model of the pump - SHURFLO8000
- Pump capacity - 6.8 dm³/min.
- Mains voltage - 230 V
- Required length of the grain conveyor - of 4m
- Required diameter of grain tank conveyor pipe - 110 to 160 mm.
- Length - 65 cm.
- Width - 37 cm.
- Height - 23 cm.
- Weight - 19 kg.

Special features :

- A precise and unique system ensures even and precise coverage of the seeds with the preparation;
- Easy to use and install. Takes no more than 15 minutes ;
- Complete package consisting of 4 different nozzle sets, long hoses bags for attachment to the conveyor belt ; a special container for precise determination of the spray quantity.
- Components from world-leading manufacturers ensure ensure high-quality and long-term problem-free operation with the unit. The unit uses parts from manufacturers ARAG, Shurflo, Hydroscand.
- Diaphragm pump, which sucks in the staining liquid itself and and ensures an even amount of spray liquid in the system. of spray liquid in the system;
- High performance. The productivity of the unit is up to 14 t/h.
- 24 months warranty.

Flex Conveyor **PSE**



Features of the PSE 90:

1. length - 3 to 11 metres.
2. power output 1.5 - 3.0 kW (depending on length)
3. capacity - 3 t/h

Features of the PSE 127:

1. length - 4 to 12 metres.
2. power 1.5 - 4.0 kW (depending on length)
3. capacity - 6 t/h

Description

Our spiral conveyor is optimally suited for the flexible transport of bulk materials (can also transport sawdust).

Different inlet systems are available to accommodate the conveyor belt:
Connection to a silo, big bag hopper, bagged goods, pipe socket, etc.

Diameter: 90 or 127 mm

KM destoner



Description

KM destoners are used in the milling and food industry in the production of various types of grain, sunflower seeds, pumpkins, etc. In addition, destoners are used to separate metal particles from plastic waste, for removing metal particles from metallurgical slag, etc.

The principle of the stone separators is to separate the product into two fractions according to its specific weight. weight in order to separate heavy impurities such as stones, glass, metal particles, etc. from the cleaned product, metal particles, etc. from the cleaned product: Grain, plastic waste, slag from metallurgical production, etc.

| Properties | KM 0.3 | KM 1.6 | KM 5.0 |
|------------------------------|--------|--------|--------|
| Capacity, up to t/h | 0.3 | 1.6 | 5.0 |
| Electricity consumption, kWh | 1.87 | 5.5 | 9.2 |
| Net weight, kg | 120 | 500 | 950 |
| -length, mm | 1000 | 2160 | 2500 |
| -Width, mm | 550 | 1100 | 1400 |
| -Height, mm | 1100 | 1350 | 1950 |